

# Suggested equipment for block building

Set of blocks for a group of 15 to 20 children  
(Numbers in parentheses refer to drawing.)

Number of blocks recommended for this age group

	3 years	4 years	5 years
Half units (1)	48	48	60
Units (2)	108	192	220
Double units (3)	96	140	190
Quadruple units (4)	48	48	72
Pillars (5)	24	48	72
Small cylinders (6)	20	32	40
Large cylinders (7)	20	24	32
Circular curves (8)	12	16	20
Elliptical curves (9)	8	16	20
Pairs of small triangles (10)	8	16	18
Pairs of large triangles (11)	4	8	12
Floor boards—11" (12)	12	30	60
Roof boards—22" (not illustrated)	0	12	20
Ramps (13)	12	32	40
Right-angle switches (14), and/or X switches (not illustrated)	0	4	8
Half pillars (not illustrated)	0	12	16
Y switches (15)	2	2	4

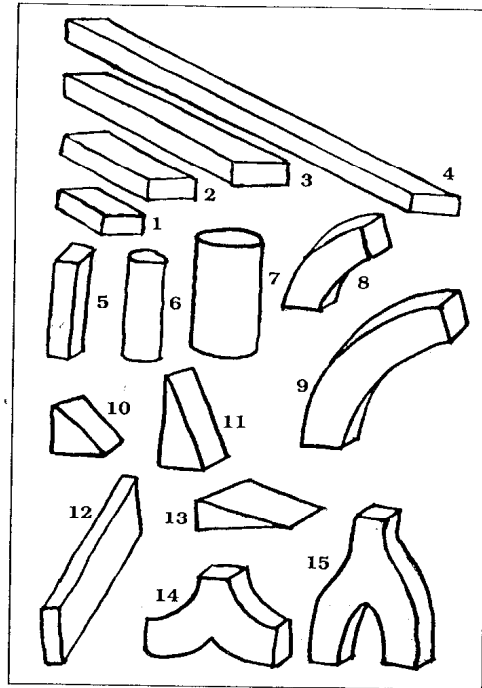

From *Play Equipment for the Nursery School* by Jessie Stanton, Alma Weisberg, and the faculty of the Bank Street School for Children.

As children have more experience with blocks, greater varieties and quantities may be needed. Four-year-olds who have used blocks actively for a year or two, for example, will often use even more blocks than suggested for 5-year-olds.











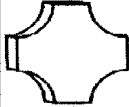

It seems that unit blocks have their own lingo when referring to sizes and shapes. Here's a chart to help you quickly navigate which shapes and sizes are available, and what to call them. The illustrations are courtesy of one of the best block makers in the business:



### Wooden Unit Block Size and Shape Chart

Illustration	Name	Size (inches)
	1/2 Unit	1-3/8 X 2-3/4 X 2-3/4
	Unit	1-3/8 X 2-3/4 X 5-1/2
	Double Unit	1-3/8 X 2-3/4 X 11
	Quad Unit	1 3/8 X 2-3/4 X 22
	1/2 Pillar	1-3/8 X 1-3/8 X 2-3/4
	Pillar	1-3/8 X 1-3/8 X 5-1/2
	Double Pillar	1-3/8 X 1-3/8 X 11
	1/2 Column (1")	Round X 2-3/4
	Column	Round X 5-1/2
	Double Column	Round X 11
	Roman Arch	1-3/8 X 2-3/4 X 5-1/2
	1/2 Circle	1-3/8 X 2-3/4 Circle
	Small Triangle	1-3/8 X 2-3/4 Triangle
	Large Triangle	1-3/8 X 5-1/2 Triangle
	Double Triangle	1-3/8 X 11 Triangle
	Ramp	1-3/8 X 5-1/2 Ramp
	1/2 Basic Flat	11/16 X 2-3/4 X 2-3/4
	Flat	11/16 X 2-3/4 X 5-1/2
	Double Flat	11/16 X 2-3/4 X 11
	Quad Flat	11/16 X 2-3/4 X 22
	Roof Board	1/8 X 5-1/2 X 11

Unit Block Sizes and Shapes » All aBout Children's wooden blocks

	Intersection	1-3/8 X 8-1/4 X 8-1/4
	Side Road	1-3/8 X 5-1/2 X 8-1/4
	1/4 Circle	1-3/8 X 2-3/4 Circle
	Large 1/2 Circle	1-3/8 X 2-3/4 X 5-1/2
	1/2 Circle Curve	1-3/8 X 5-1/2 X 5-1/2
	Circle Curve	1-3/8 X 5-1/2 X 11
	Small Switch	1-3/8 X 5-1/2 X 8-1/4
	Gothic Arch	1-3/8 X 11" x 8-1/4
	1/2 Gothic Arch	1-3/8 X 2-3/4 X 5-1/2
	Small Buttress	1-3/8 X 1-3/8 X 4-1/8
	Gothic Door	1-3/8 X 5-1/2 X 2-3/4
	1/2 Roman Arch	1-3/8 X 2-3/4 X 2-3/4
	Notched Half Unit	1-3/8 X 2-3/4 X 2-3/4

Uncategorized unit blocks

[Trackback URI](#) | [Comments](#) [RSS](#)

**Leave a Comment Below**

You must be [logged in](#) to post a comment.

[Print This Page](#)

All aBout Children's wooden blocks © 2007 All Rights Reserved. WordPress Theme by [Venetian Blinds](#)

[Back to Top](#)

Rainbow Style is Sponsored by: [Nature Pictures](#), [Cyprus Holidays](#), [Walk in Baths & Vista Themes](#)